

# ABRA, CHEGOU!

ABRA  
c a s a

## Estante Mosaico 180cm

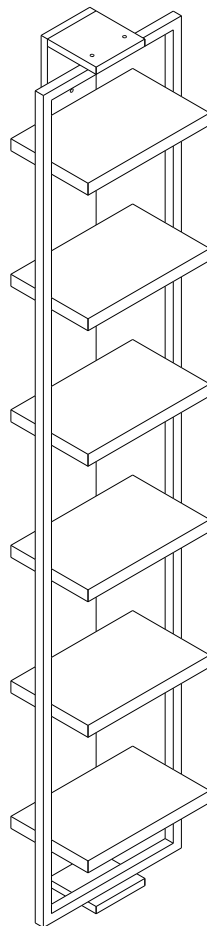

### montagem:



necessário 1 pessoa para a montagem do produto.



produto pesado, cuidado!

### cuidados:



evitar contato com objetos cortantes



não utilizar produtos abrasivos na limpeza



limpeza com pano úmido, secar logo em seguida

PARTES:

- Ⓟ P1 Prateleira **x 6**
- Ⓟ P2 Travessa menor **x 2**
- Ⓟ P3 Travessa maior **x 1**
- Ⓟ P4 Estrutura Metálica **x 1**

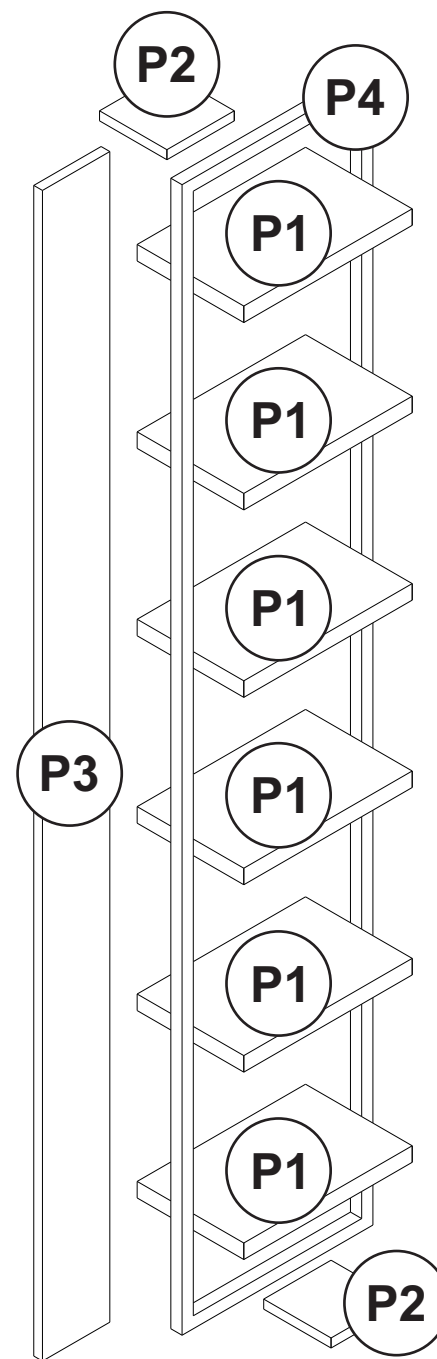

Confira se todos os componentes e partes do seu móvel estão corretos, antes de iniciar a montagem.

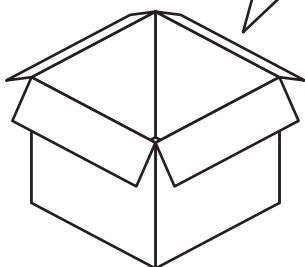

## COMPONENTES:

**A**

Parafuso 7x50 **x12**



**F**

Parafuso 4x30 **x04**



**B**

Parafuso 3,5x40 **x04**



**C**

Parafuso 5x60 **x03**



**D**

Bucha 8mm **x02**



**E**

Chave Zeta **x01**

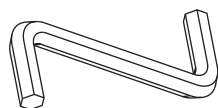

Confira se todos os componentes e partes do seu móvel estão corretos, **antes de iniciar a montagem.**

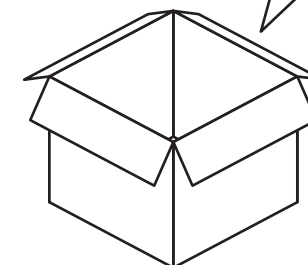

# MONTAGEM:

**1.** Junte as peças P1 e P2 na peça P3. Encaixe e parafuse a letra A nas peças usando a Chave Zeta (E).

**A**

Parafuso 7x50 **x12**

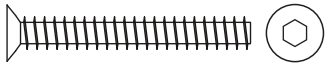

**B**

Parafuso 3,5x40 **x04**



**E**

Chave Zeta **x01**

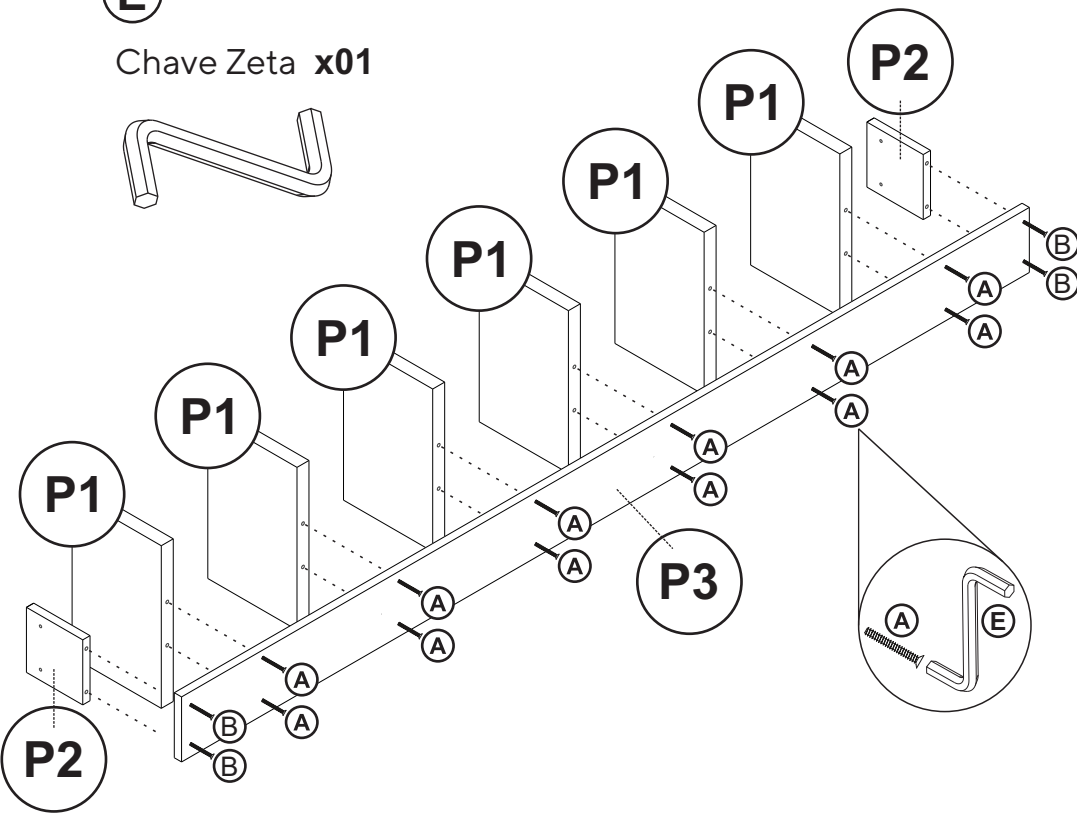
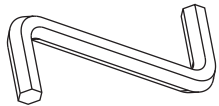

**2.**

Encaixe a estrutura metálica (P4) entre as peças e parafuse a letra F nas peças P2 para fixá-la.

**F**

Parafuso 4x30 **x04**

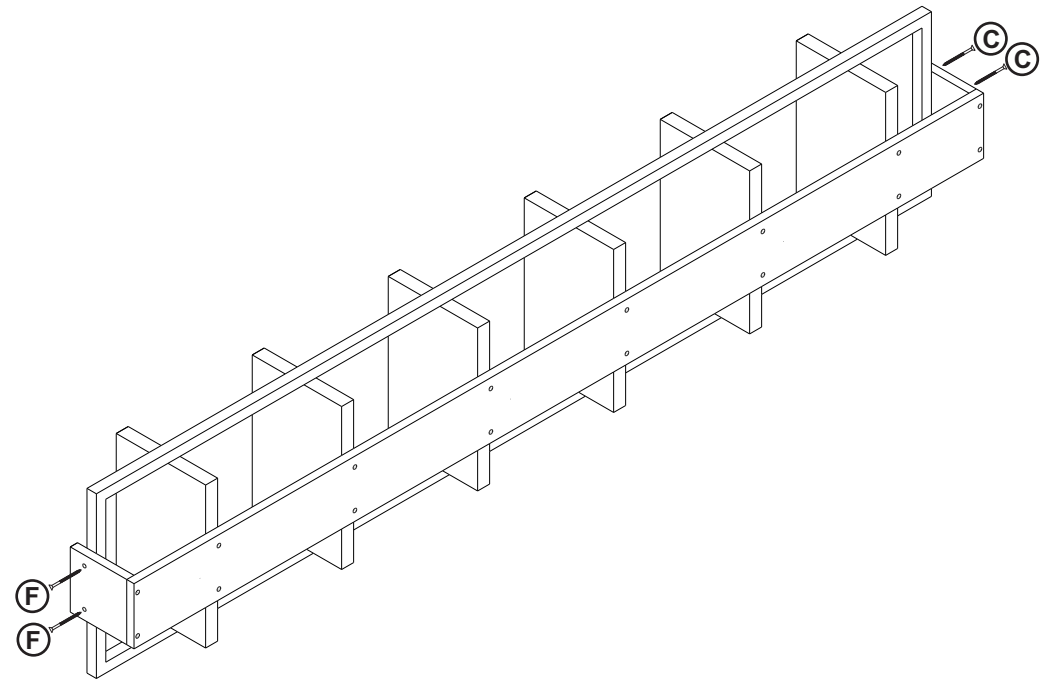

## MONTAGEM:

- 3.** Faça a marcação na parede, fure, coloque as buchas (D), encaixe o móvel e em seguida parafuse a letra C nas buchas.

**C**

Parafuso 5x60 **x03**



**D**

Bucha 8mm **x02**

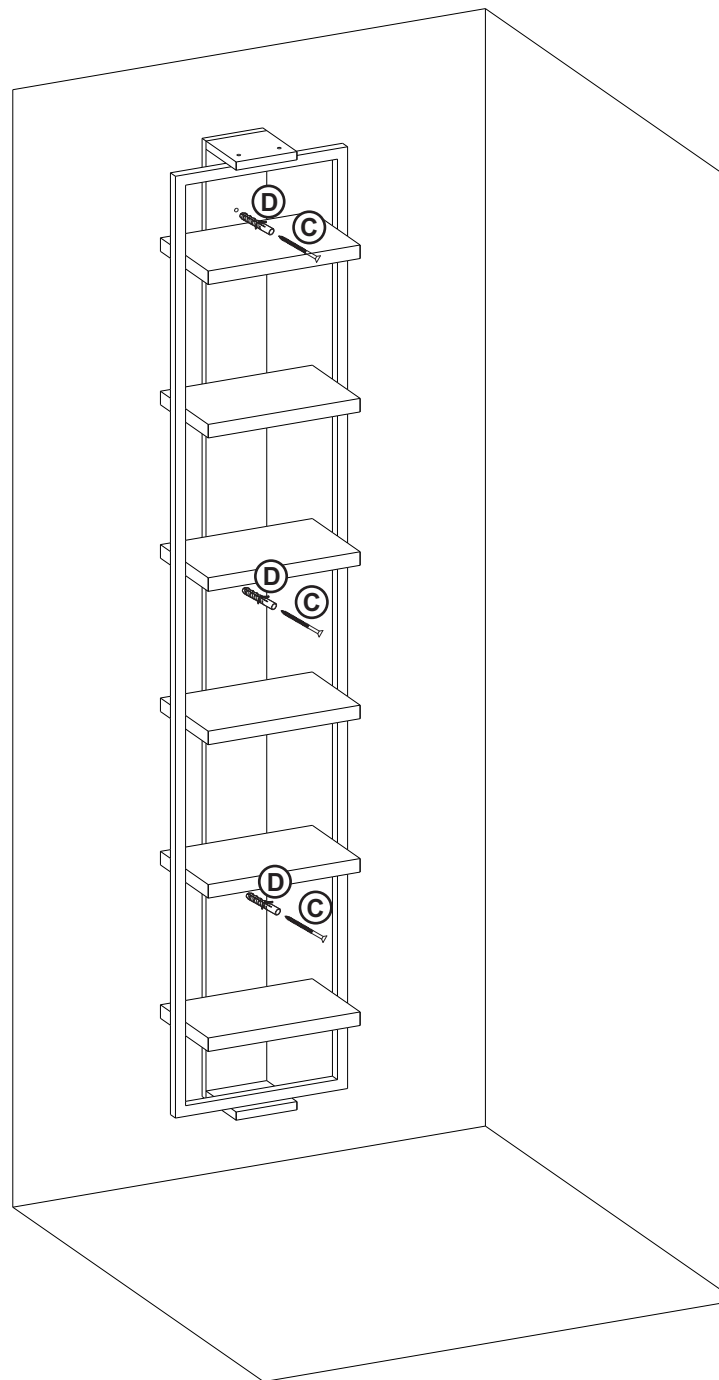

## MONTAGEM:

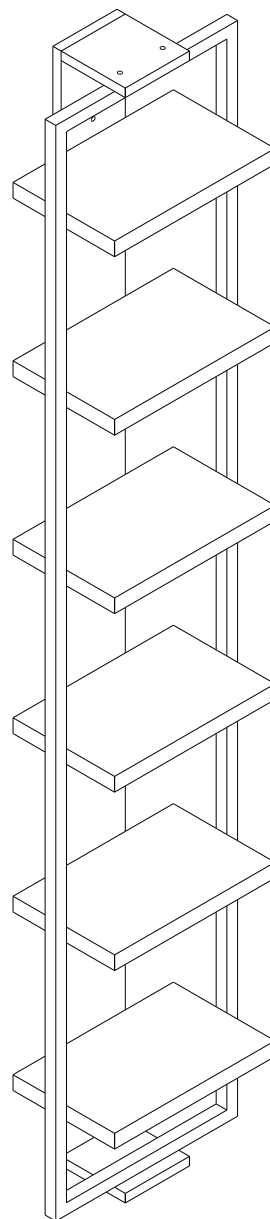

Se tiver dúvidas ou problemas durante sua montagem, nos mande uma mensagem no WhatsApp. +55(21) 97117-4398



A sua avaliação é muito importante para a nossa constante melhoria, não esqueça de nos avaliar.