

ABRA, CHEGOU!

ABRA
c a s a

Buffet Chico 3 Portas

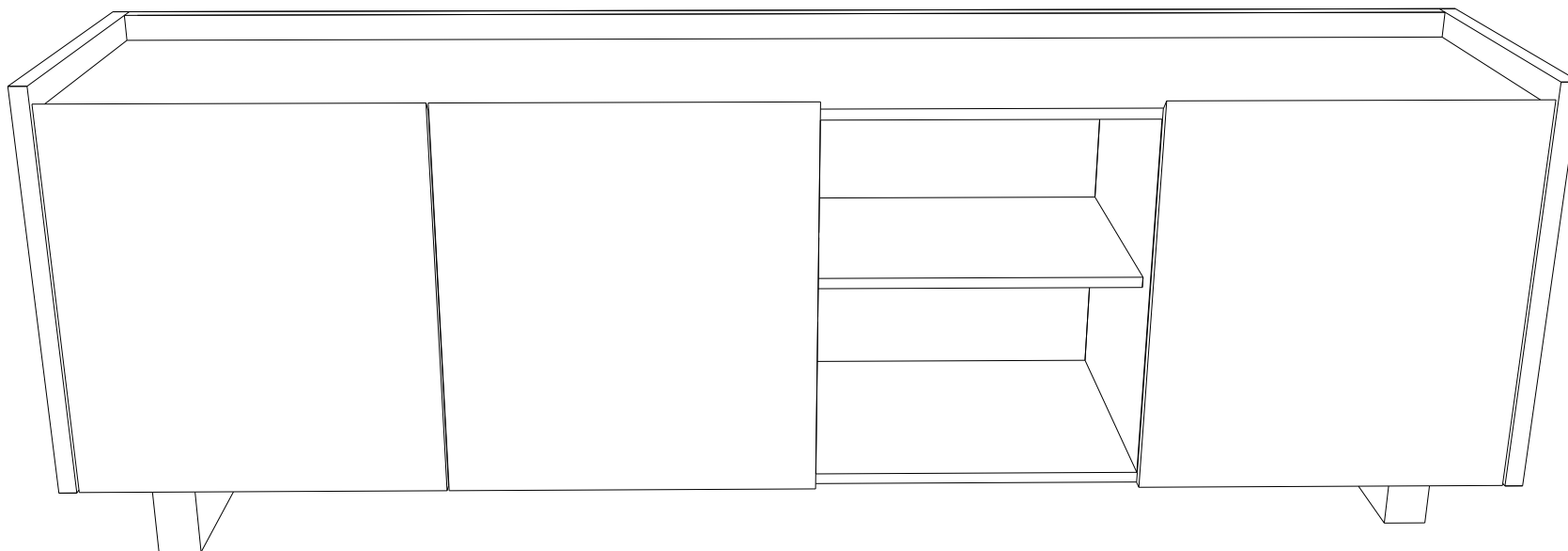

montagem:



necessário uma pessoa para a montagem do produto.



produto pesado, cuidado!

cuidados:



carga máxima suportada no tampo



carga máxima suportada por prateleira



evitar contato com objetos cortantes



não utilizar produtos abrasivos na limpeza



limpeza com pano úmido, secar logo em seguida

PARTES:

- Ⓟ P1 Base
- Ⓟ P2 Tampo
- Ⓟ P3 Lateral Direita
- Ⓟ P4 Lateral Esquerda
- Ⓟ P5 Travessa
- Ⓟ P6 Divisória Direita
- Ⓟ P7 Divisória Esquerda
- Ⓟ P8 Divisória Central
- Ⓟ P9 Prateleira Maior **x 03**
- Ⓟ P10 Prateleira
- Ⓟ P11 Porta Direita **x 02**
- Ⓟ P12 Porta Esquerda
- Ⓟ P12 Fundo
- Ⓟ P13 Pé
- Ⓟ P14 Travessa Pé

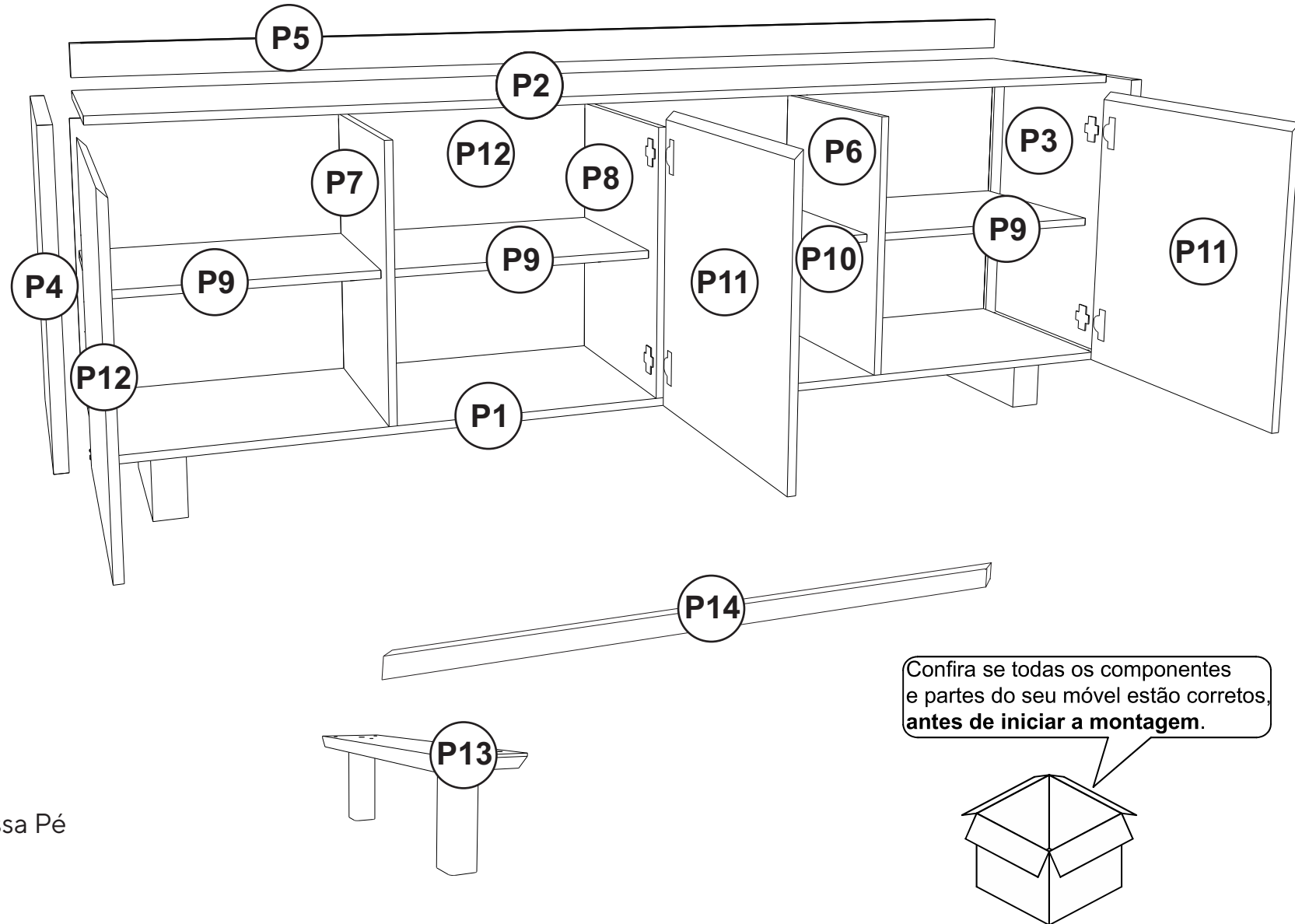

COMPONENTES:

A

Cavilha Madeira 8x30 x **20**



B

Pino Plástico Marrom x **16**



C

Parafuso 4x30 x **08**



D

Minifix x **14**



E

Tambor x **14**



F

Parafuso 3,5x16 x **36**



G

Dobradiça com amortecedor x **04**
Super curva

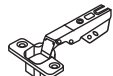

H

Dob. reta com Amortecedor x **02**

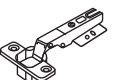

I

Parafuso 3,5x40 x **06**



J

Parafuso 4x25 flangeado x **05**



K

Chave Zeta



L

Parafuso 7x50 x **09**



M

Parafuso 5x45 flangeado x **05**



O

Parafuso 5x60 x **01**



Confira se todas os componentes e partes do seu móvel estão corretos, antes de iniciar a montagem.

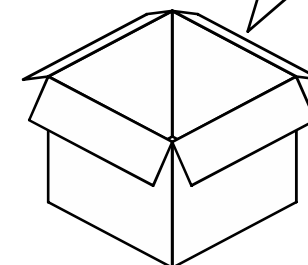

PREPARAÇÃO:

A

Cavilha Madeira 8x30 x 20

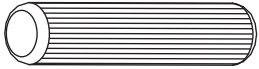

B

Pino Plástico x 16



D

Minifix x 14

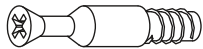

F

Parafuso 3,5x16 x 12



G

Dobradiça com amortecedor x 04

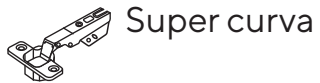

H

Dob. reta com Amortecedor x 02

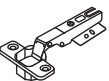

L

Parafuso 7x50 x 04

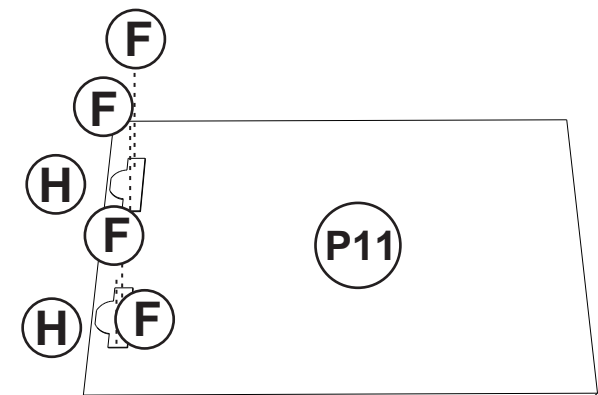
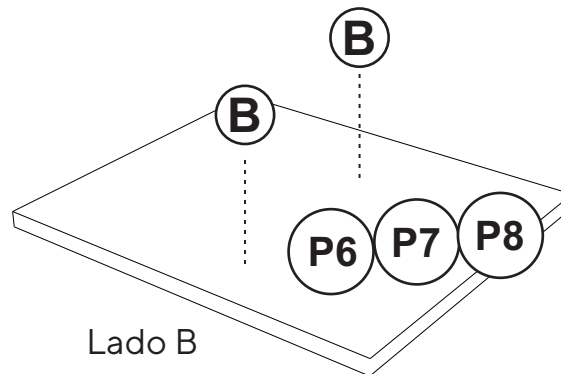
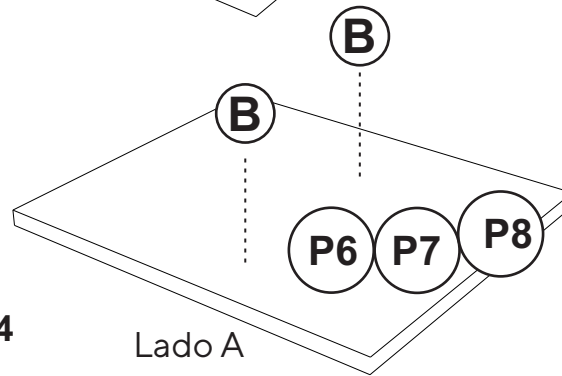
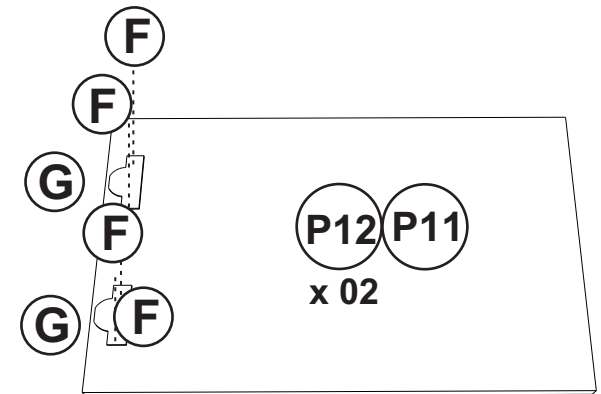
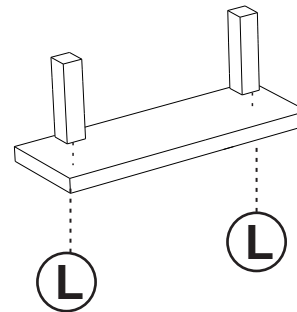
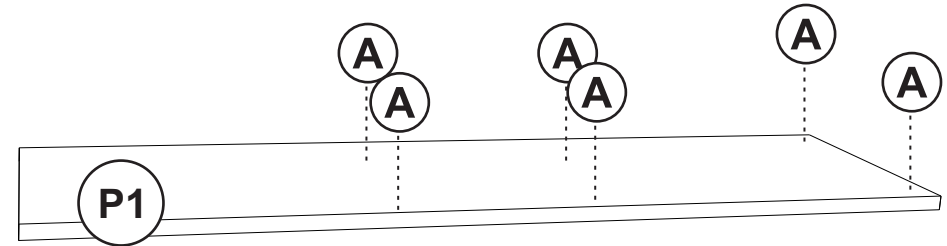
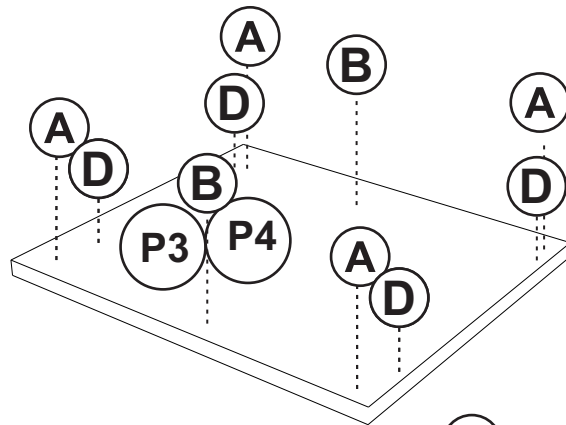
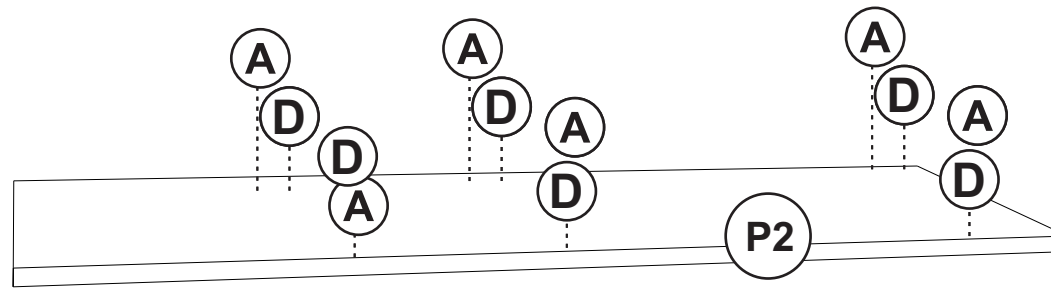

MONTAGEM:

1. Encaixe as peças P6, P7 e P8.
2. Parafuse com a letra E.

E

Tambor x 06

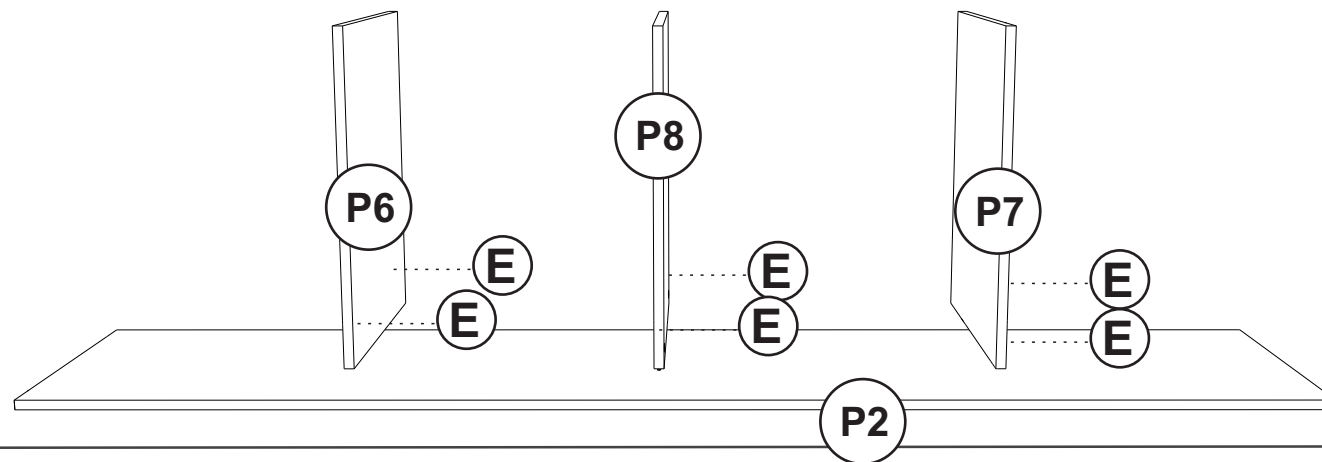

2. Encaixe a peça P1 e parafuse com a letra I.

I

Parafuso 3,5x40 x 06

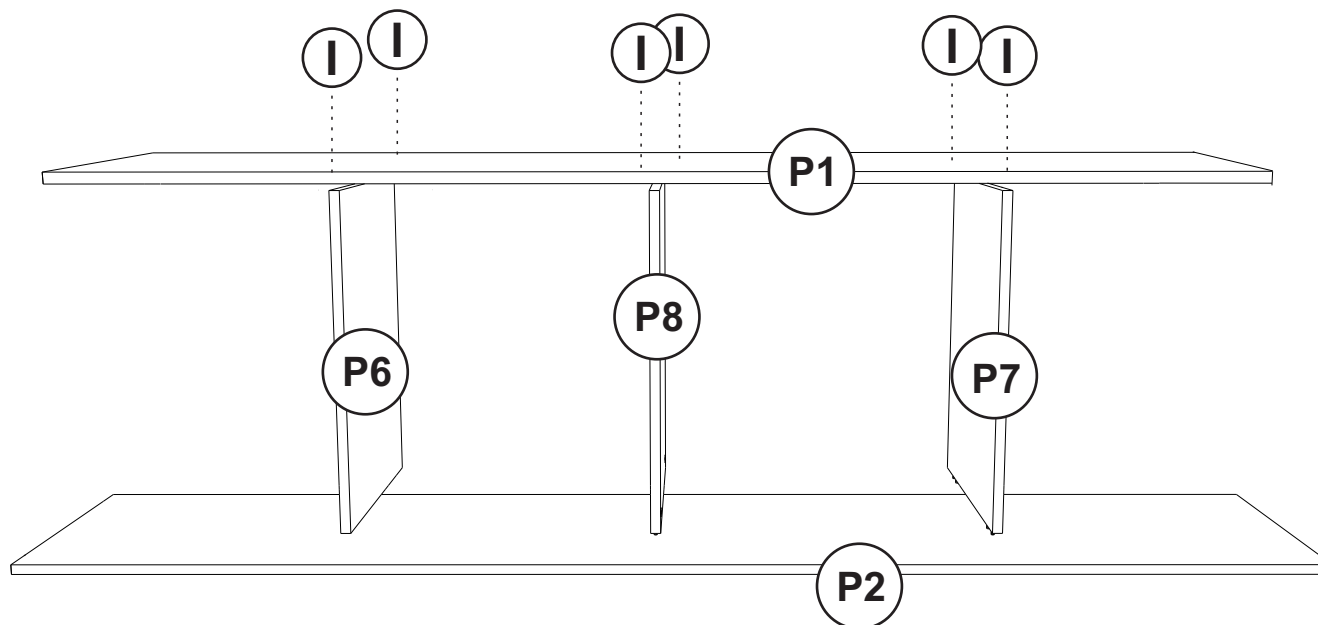

MONTAGEM:

- 3.** 1. Encaixe as peças P3 e P4 nas peças P2, P1.

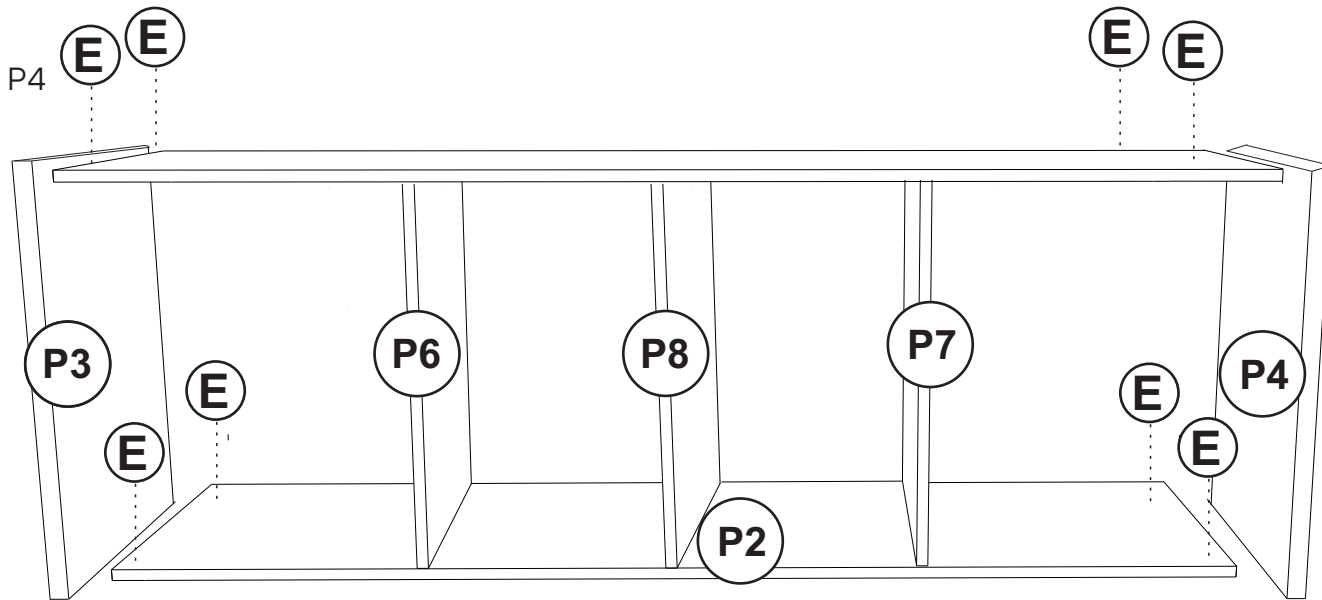

- 4.** 1. Parafuse as peças P12 com a letra L e J.

L
Parafuso 7x50 x 04



J
Parafuso 4x25 flangeado x 05



K
Chave Zeta

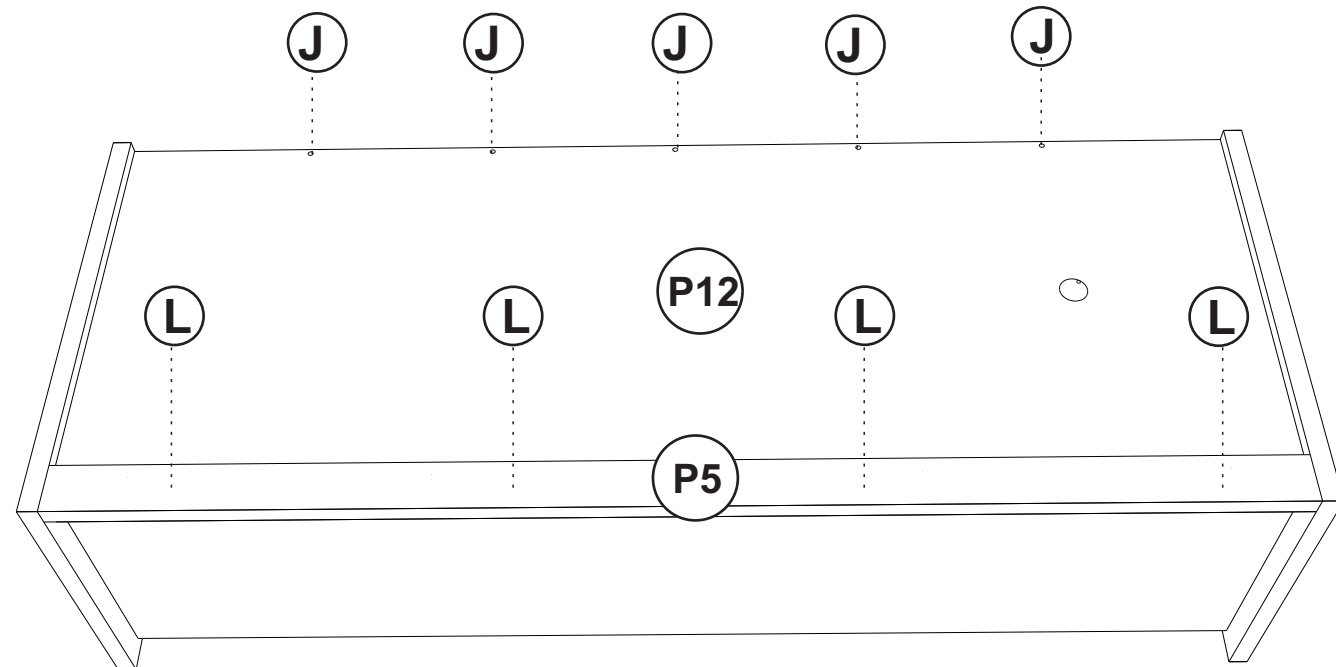

MONTAGEM:

5.

C

Parafuso 4x30 x 08

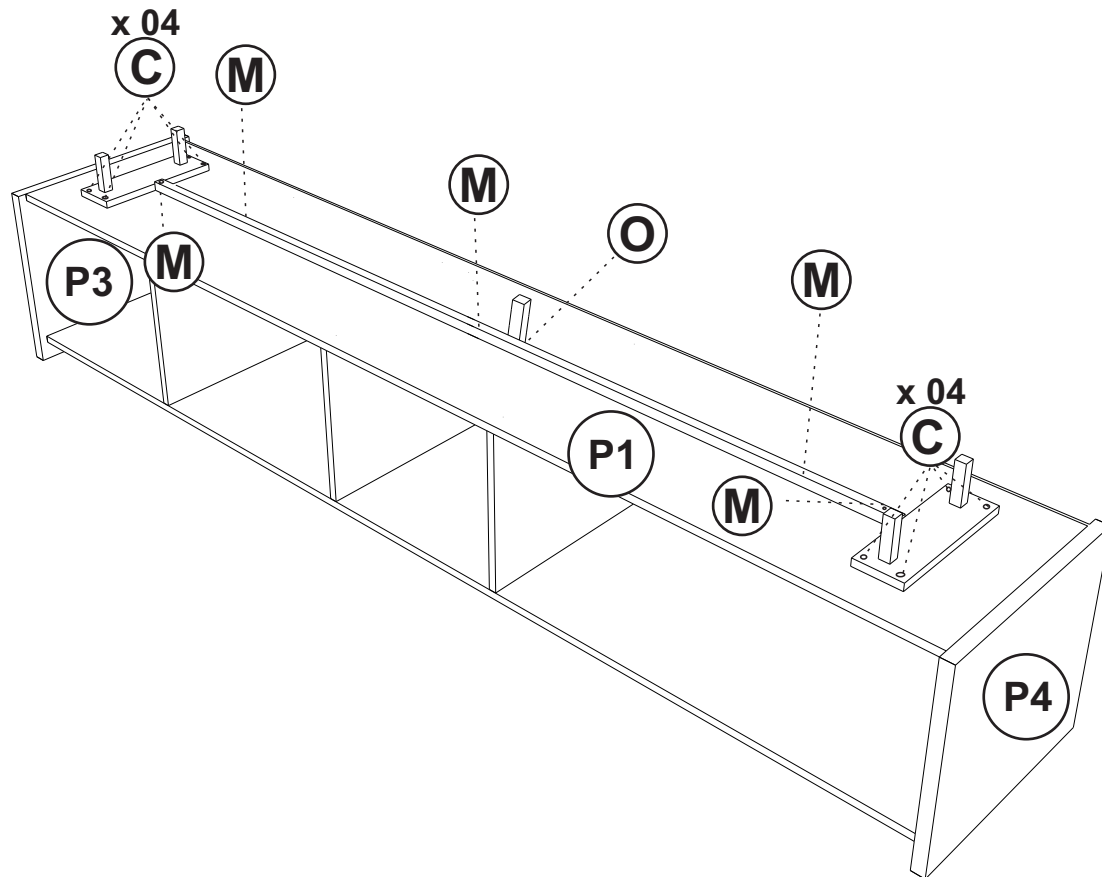

M



Parafuso 5x45 x 05

O

Parafuso 5x60 x 01



6.

1. Fixe o calço das dobradiças G e H que estão nas peças P11 e P12 sobre as peças P3, P4 e P8 com parafusos F.

2. Encaixe as prateleiras.

F

Parafuso 3,5x16 x 24

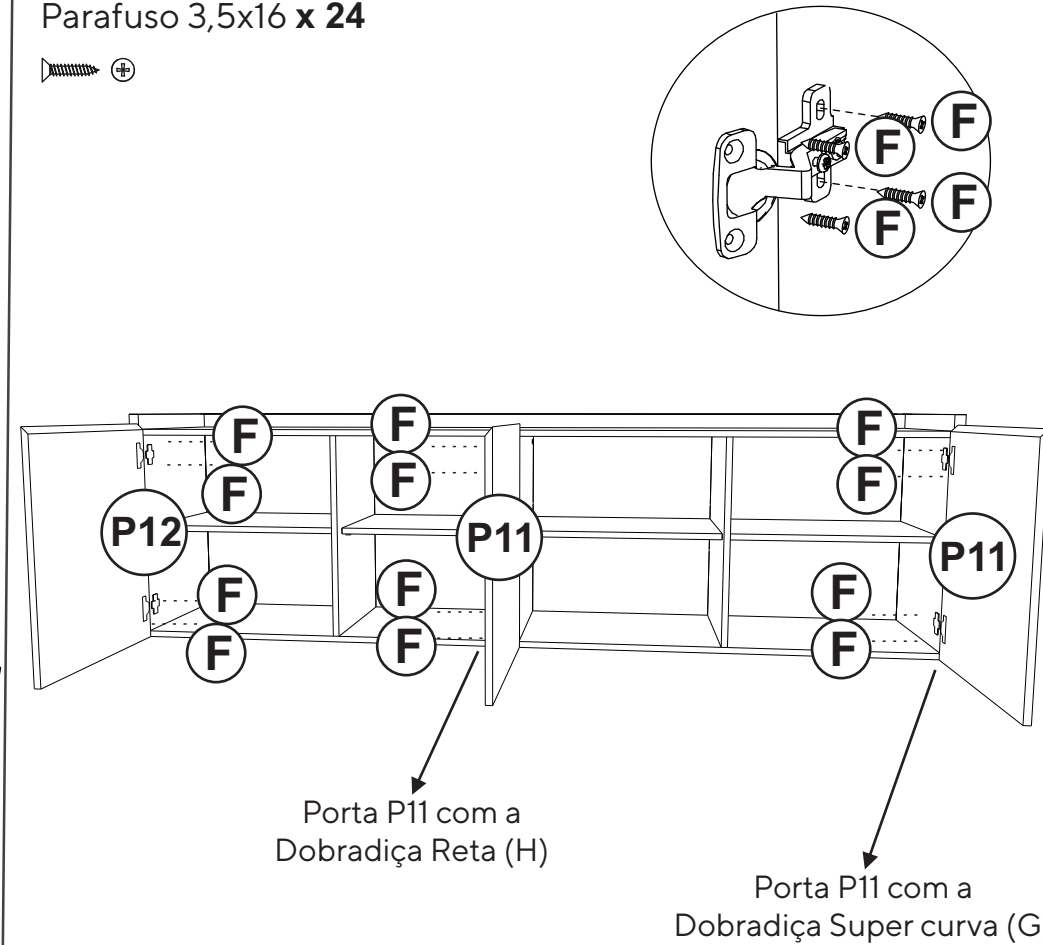

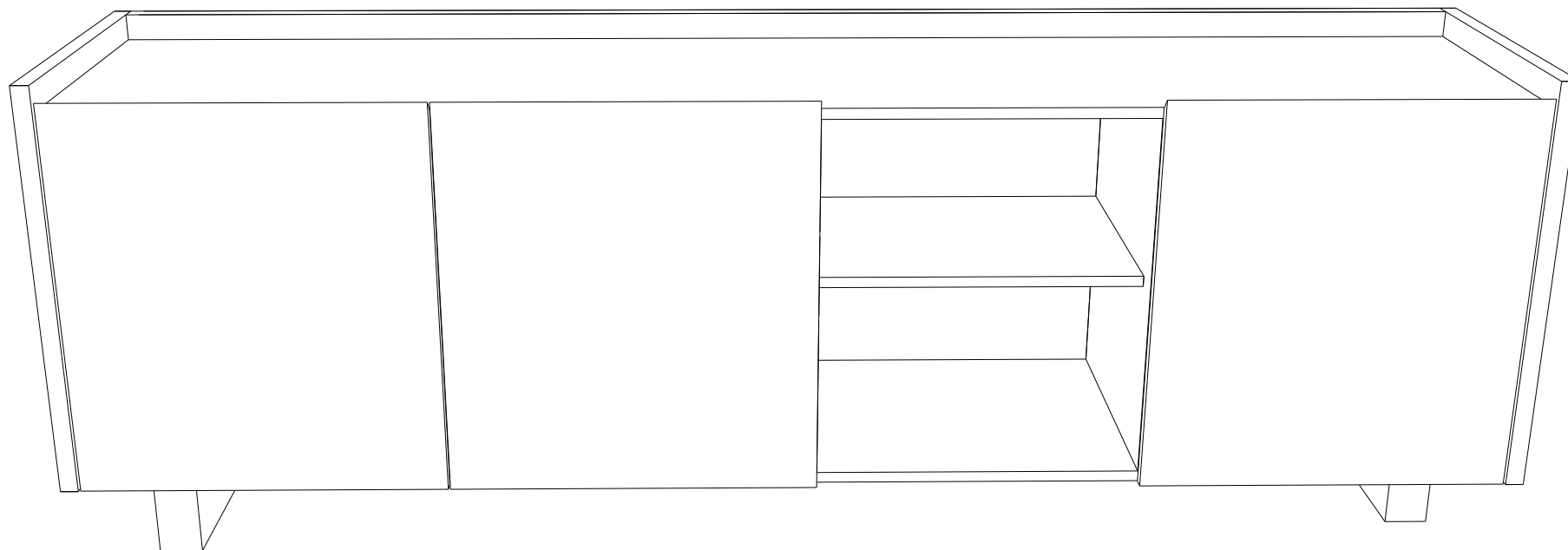

Se tiver dúvidas ou problemas durante sua montagem, nos mande uma mensagem no WhatsApp. +55(21) 97117-4398



A sua avaliação é muito importante para a nossa constante melhoria, não esqueça de nos avaliar.